



VI

视觉识别系统
设计册



廣漢市中醫醫院
GUANGHAN HOSPITAL OF TRADITIONAL MEDICINE



医院logo、院训配色与字体设计



广汉市中醫醫院
GUANGHAN HOSPITAL OF TRADITIONAL MEDICINE

医院logo配色

C65 M64 Y64 K13

C13 M40 Y72 K0



广汉市中醫醫院
GUANGHAN HOSPITAL OF TRADITIONAL MEDICINE

罗永嵩手写字体

方正小标宋

博古納今
精誠創新

李旭科行书毛笔字

广汉市中医医院logo设计图解

雕刻版本



印刷版本



配色：
logo设计主要采用棕色、白色、金色三个色彩。
符合中医厚重久远的气质特征。

葫芦



葫芦寓意“悬壶济世”，指医者仁心，以医技普济众生，世人称之之意。医院成立的初衷通过医学普济众生，护航生命，通过传承和弘扬中医药文化，进而能让中医更好的为百姓的健康保驾护航。
“中医”二字放在葫芦中间代表着广汉市中医医院将秉着悬壶济世的宗旨，将中医药事业做实、做强。

古文字



中医诞生于原始社会，春秋战国时期中医理论已基本形成，之后历代均有总结发展。葫芦中的“中医”二字，“中”字是甲骨文、“医”是金文，起源于商朝后期，是目前我们能见到的最早的成系统的汉字，寓意着中医的历史悠久，源远流长。古文字“中医”是对医院服务类别的准确定位，同时也代表着中医医院是对中国文化的传承。

青铜凤鸟追日图（原创）



鸟的图腾代表青铜凤鸟，圆点代表太阳。古蜀盛行鸟崇拜之风，对凤鸟一族崇拜的实质是太阳及太阳神崇拜，有祥瑞和与富泽的寓意。青铜凤鸟是三星堆出土文物标志性的代表之一，在院徽里面代表着广汉市区域性文化特征，也寓意医院未来发展将呈金凤追日，迎来蓬勃发展。

时间

1958

“1958”年是广汉市中医医院成立的时间。



医院导视系统设计理念、材质

设计理念

结合医院康复楼、住院楼外部改造和内部新中式的装修风格，医院导视系统设计将选择与装修配色符合的色调，以白、灰、木纹为主，采用极简风格，通过画卷、中式雕花、仿石材肌理背景、雕刻等元素的体现浓郁的中国风。



纯白

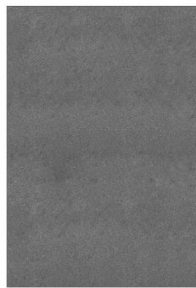

仿石材肌理



木纹



雕刻



pvc材质



亚克力材质



室内导视系统设计

门牌



诊断室门牌

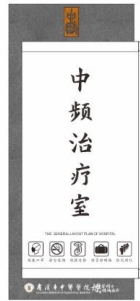

治疗室门牌



病房门牌



卫生间门牌

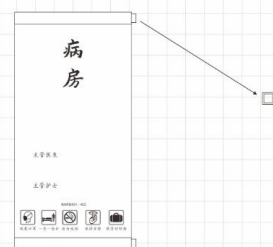
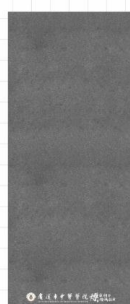
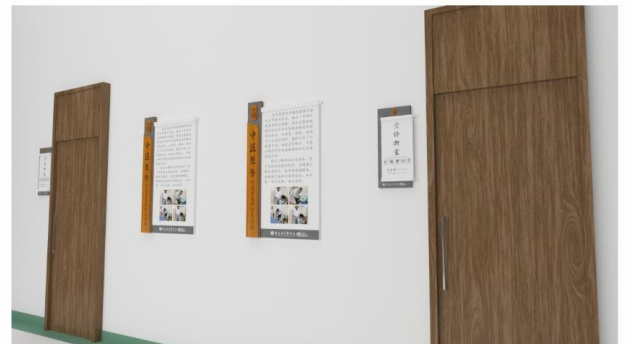
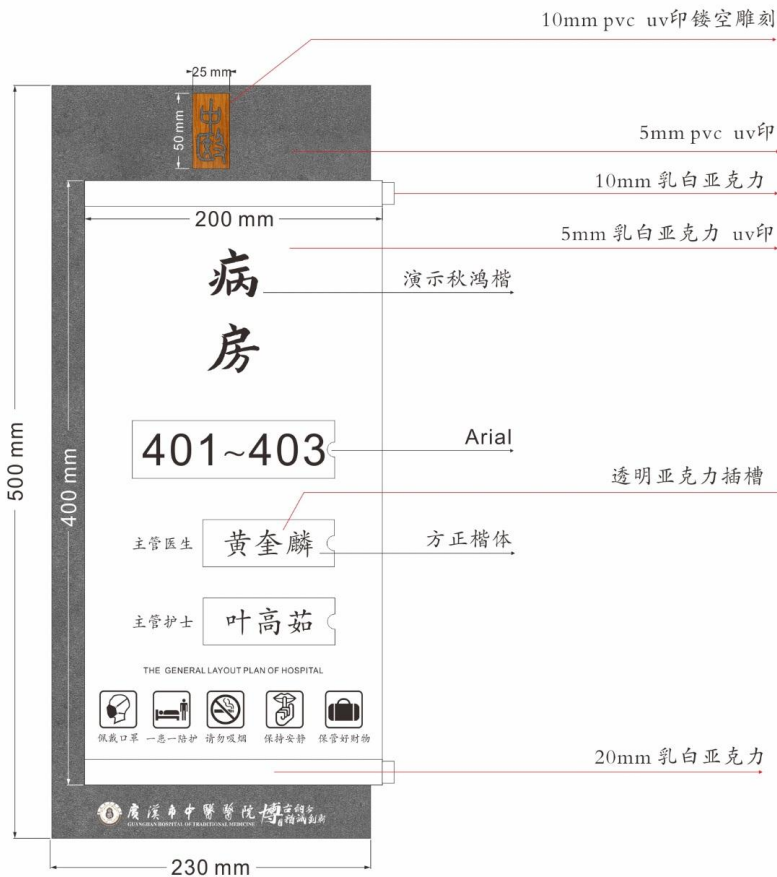

1:1制作文件



室内导视系统设计

温馨提示牌

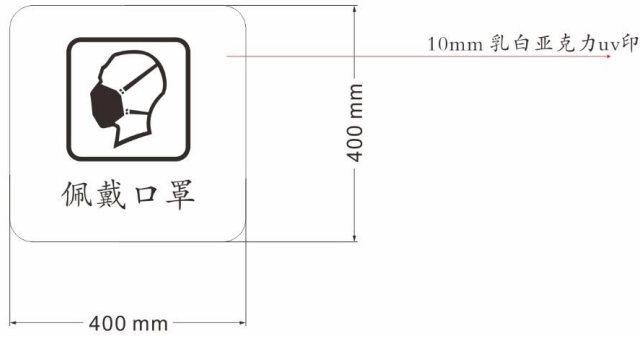

 一患一诊室	 依次排队	 间隔1米	 保持安静	 禁止拍照
 小心地滑	 禁止吸烟	 保持清洁	 节约用纸	 保管好财物
 一患一陪护	 小心辐射	 医疗废物	 孕妇止步	 小心有毒
 禁止携带宠物	 小心有电	 禁止触摸	 高危药品	 禁止翻越

1:1制作文件



室内导视系统设计

病房窗口卡

住院号	210302521	入院时间	2021.3.13		
姓名	付寿平	性别	女	年龄	80
入院诊断	慢性阻塞性肺病伴有急性加重				

10mm pvc板uv印

方正大标宋

透明亚克力插槽

演示秋鸿楷

6床

主管医生:杜锦辉	护理级别:一级
责任护士:曹林	饮食:低盐低脂糖尿病



住院号	210302521	入院时间	2021.3.13		
姓名	付寿平	性别	女	年龄	80
入院诊断	慢性阻塞性肺病伴有急性加重				

6床

主管医生:杜锦辉	护理级别:一级
责任护士:曹林	饮食:低盐低脂糖尿病

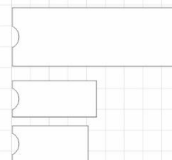
住院号	210302521	入院时间	2021.3.13		
姓名	付寿平	性别	女	年龄	80
入院诊断	慢性阻塞性肺病伴有急性加重				

6床

护理级别:一级	饮食:低盐低脂糖尿病
主管医生:杜锦辉	
责任护士:曹林	

1:1制作文件

室内导视系统设计

壁挂式展板

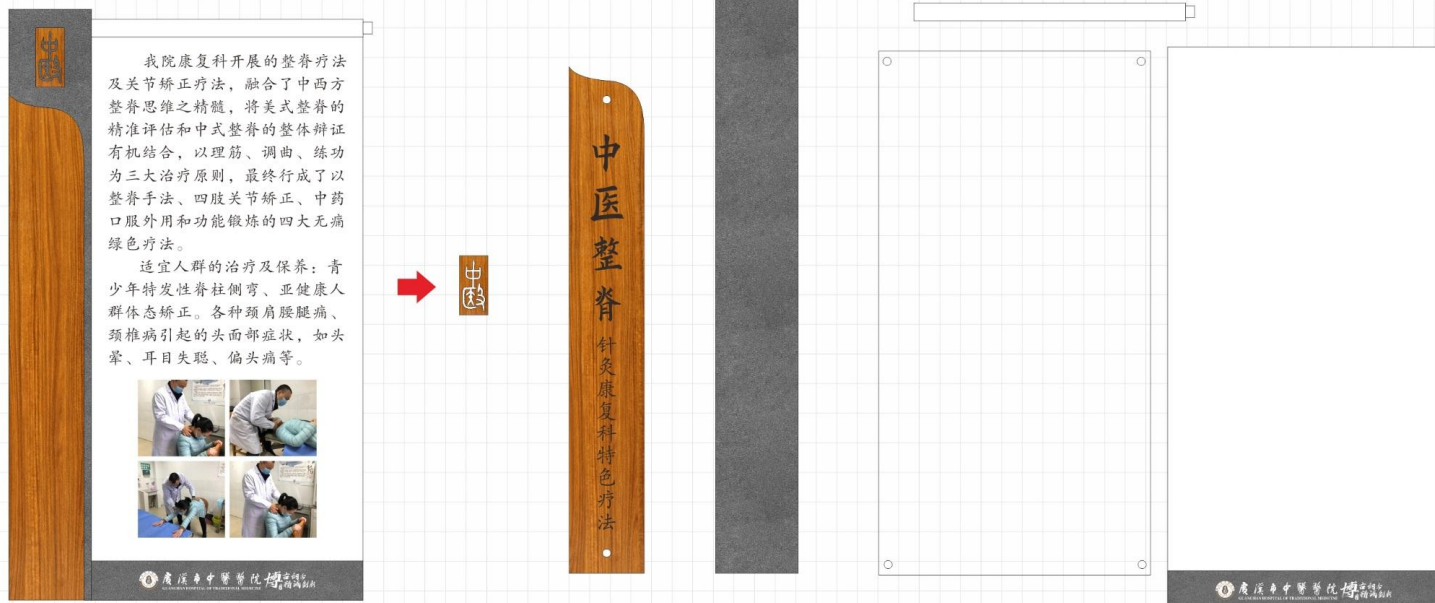
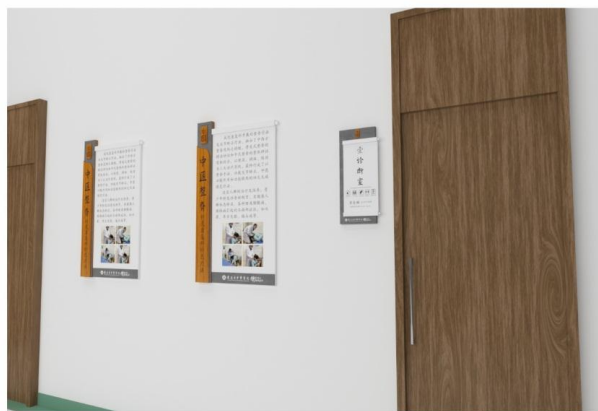
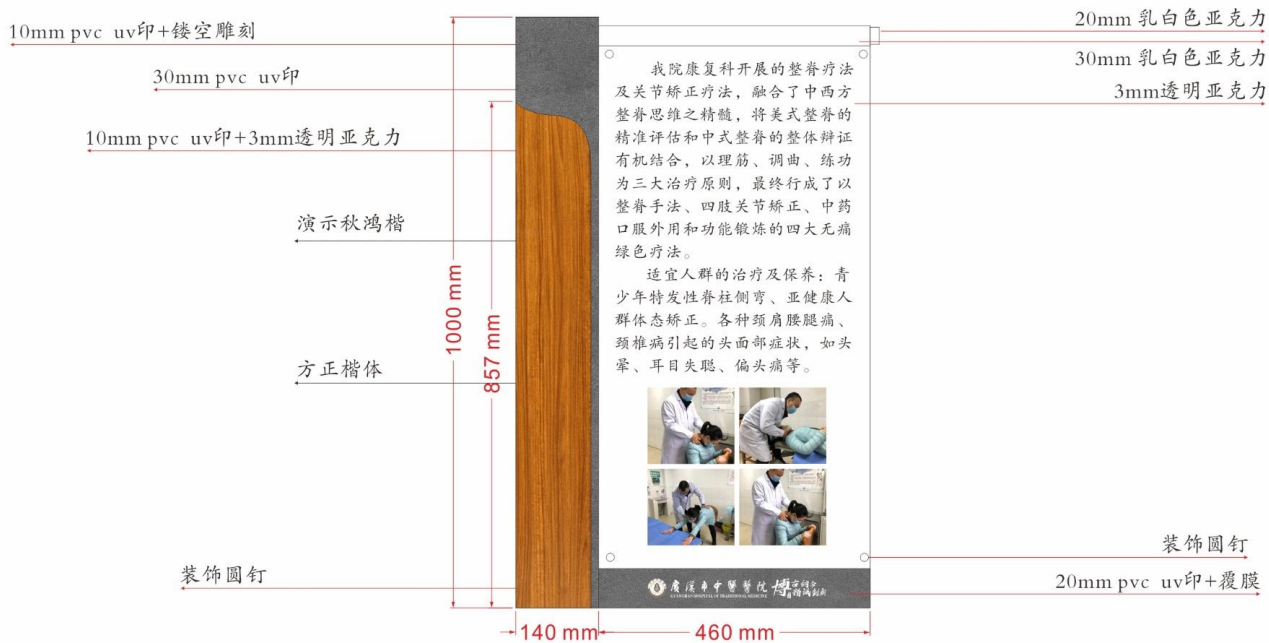



室内导视系统设计

悬挂式灯箱及吊牌

软膜灯箱



吊牌



1:1制作文件



室内导视系统设计

楼层指引横牌



■ 评估室

■ 语言训练室

■ 中医治疗室

■ 吞咽训练室

■ 音乐训练室

■ 机构化教学室

■ 感化训练室

■ 多感官训练室



■ 评估室

■ 语言训练室

■ 中医治疗室

■ 吞咽训练室

■ 音乐训练室

■ 机构化教学室

■ 感化训练室

■ 多感官训练室

1:1制作文件



室内导视系统设计

楼层指引竖牌

20mm pvc UV印

10mm pvc UV印 独立板块



1:1制作文件



室内导视系统设计

夜间双面提示灯箱



3M灯箱电脑写真喷绘



室内导视系统设计

玻璃门腰条

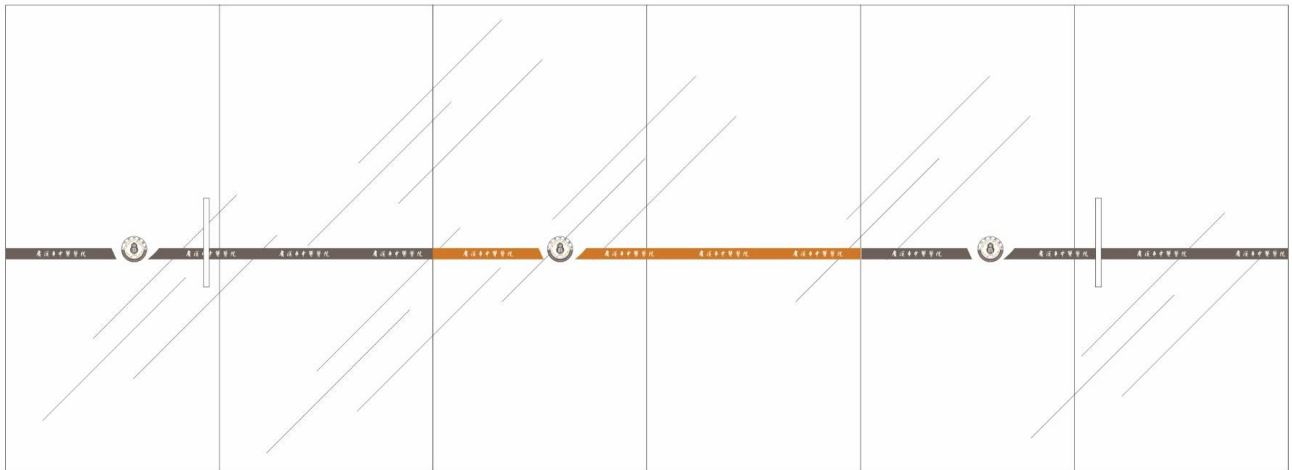



室外导视系统设计

户外指引立牌

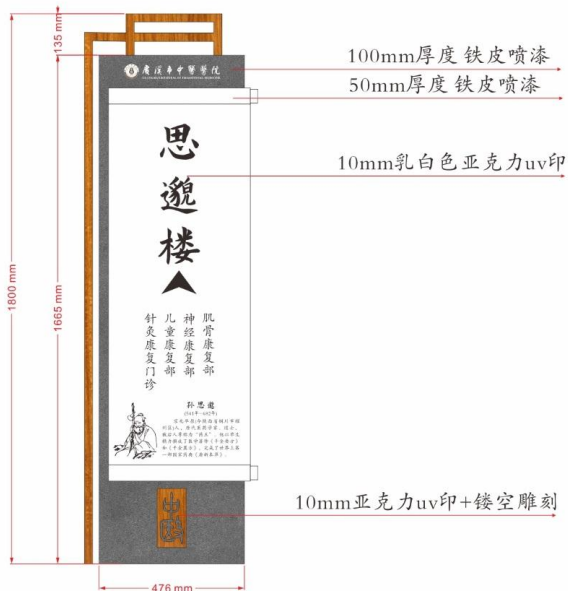

1:1制作文件



室外导视系统设计

户外指引立牌

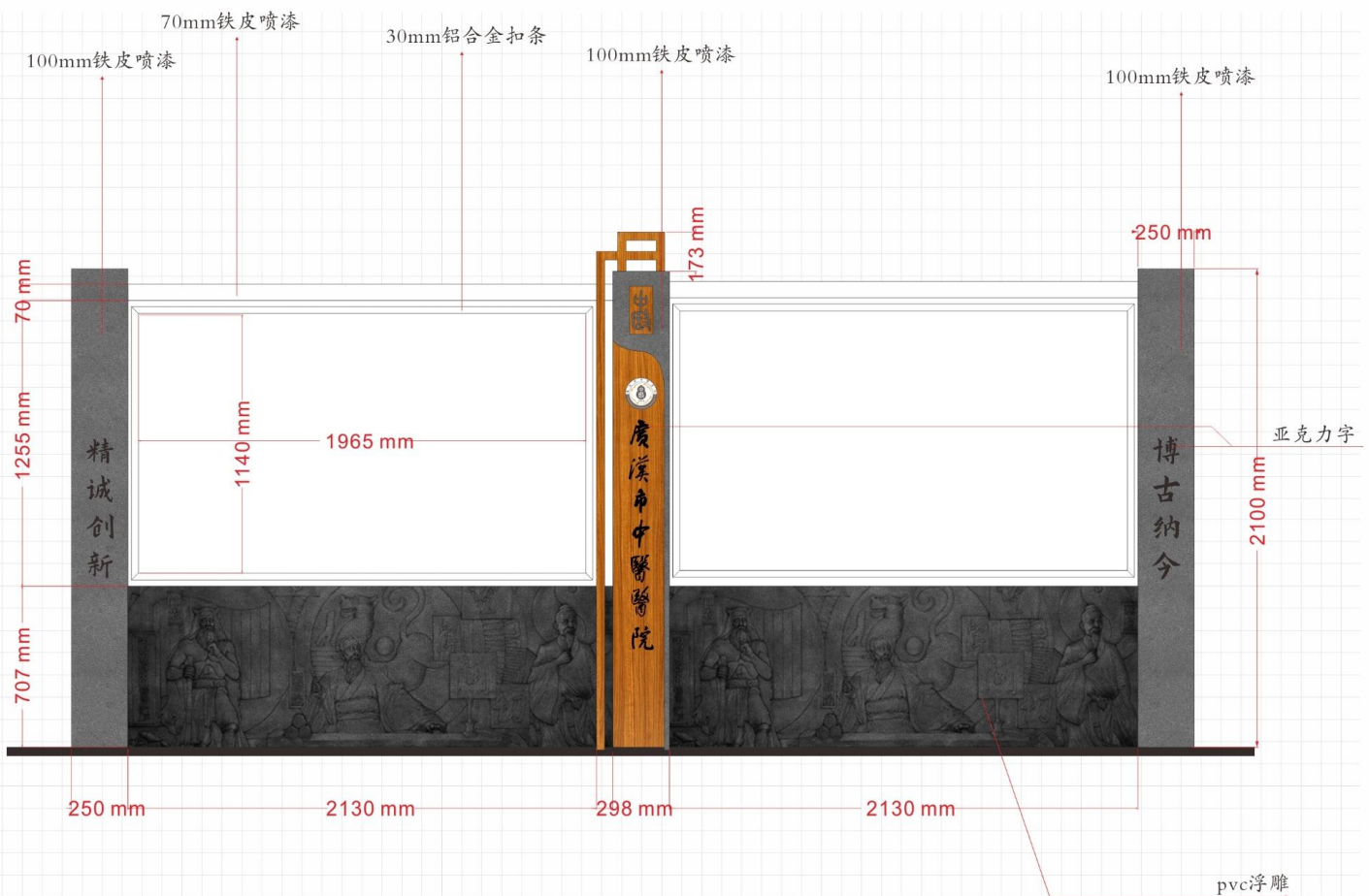

1:1制作文件



室外导视系统设计

指路牌

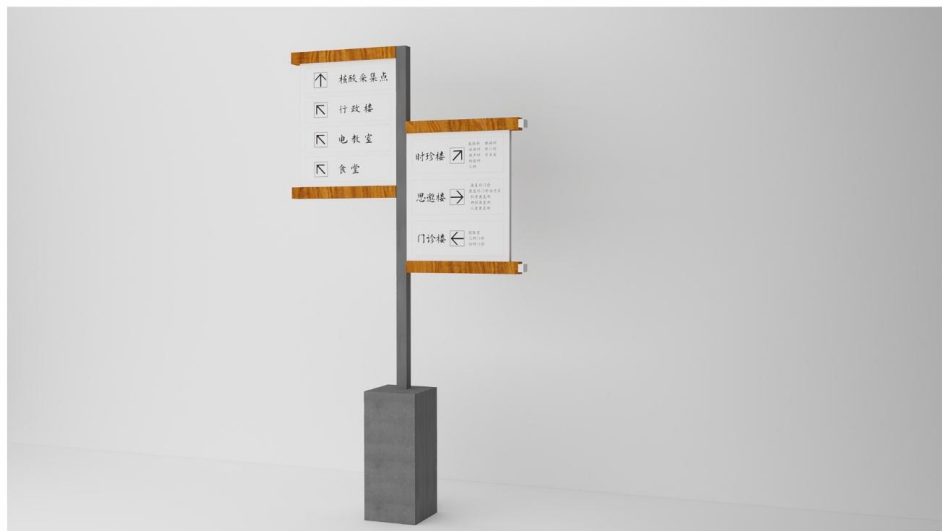
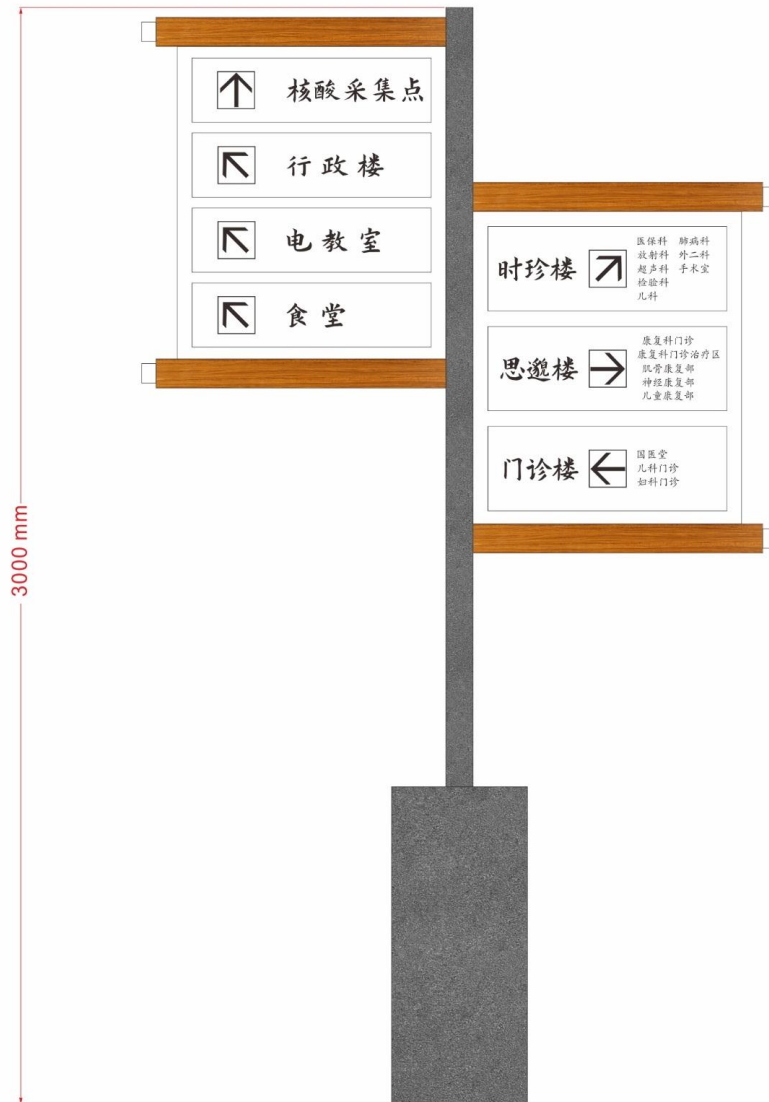



廣漢市中醫醫院

GUANGHAN HOSPITAL OF TRADITIONAL MEDICINE

廣漢市雒城街道東西大街西二段147號

博古納今
精誠創新